

OPERATING INSTRUCTIONS PC3 HOIST

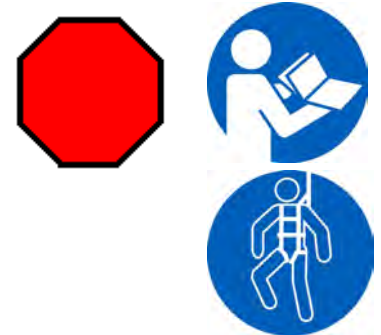

WARNING

- **All persons** operating this equipment **must** read and completely understand this manual
- **All persons** must be thoroughly trained in the use of the equipment, its operational and safety features, and they must also be capable of carrying out the daily inspections.
- Only authorized persons shall operate the equipment.
- Any operation in violation of these instructions is at the **operator's own risk** and **may result in serious injuries**.
- Keep this manual with the hoist at all times.
- Use only spare parts and recommended steel wire rope from Power Climber®.
- It is the responsibility of the user of this hoist to determine that this hoist is suitable to be used in conjunction with any other equipment. The user must also determine that this hoist and other components used will be in strict conformity with the provisions of Federal, State, National and local ordinances and regulations.

Table of Contents

1. INTRODUCTION	page 3
a. Features list	3- 4
b. GENERAL SPECIFICATIONS	5
2. HAZARD SYMBOLS SUMMARY	5
3. SAFETY SUMMARY	6
a. MECHANICAL	9
b. ELECTRICAL	9
c. ENVIRONMENTAL	9
d. HAZARD PREVENTION	10
4. WIRE ROPE	10
a. GENERAL SPECIFICATIONS	10
b. Preparation for Reeving	10
c. Inspection	11
5. HOIST	12
a. FRONT AND BACK VIEWS OF THE HOIST	12
b. INSTALLING TO A PLATFORM	13
c. REEVING THE WIRE ROPE	14
i. Main suspension wire rope	14
ii. Secondary Wire Rope (optional)	14
d. DAILY TEST REQUIREMENTS	15
i. Testing the Overspeed Brake	15
ii. Testing the Overspeed Brake Test Button	16
iii. Resetting the Overspeed Brake	17
iv. Testing the Emergency Stop (power cut-off)	17
v. Testing the Controlled Descent Feature	18
e. DAILY INSPECTION	19
f. OPERATING THE HOIST	19
i. Normal Operation	20
ii. Cold Weather Operation	21
g. DEREEVING	21
i. Removing the main suspension wire rope	21
ii. Removing the secondary wire rope (optional)	22
h. MAINTENANCE REQUIREMENTS	23
7. TROUBLESHOOTING GUIDELINES	23-26
8. HOIST LABELS	26

INTRODUCTION

The PC3 is used to raise, support and lower suspended scaffolds, work cages and bosun chairs on, or in building(s) and structures. If used for any other purpose, you must take all necessary precautions to be sure that both design and operation are hazard free, and such use conforms with manufacturer's specifications.

Before using the PC3, learn the procedures described in this manual. Any operation in violation of these instructions may result in bodily injury or death. The design and manufacturing of the PC3 must comply with UL1323 standard and CUL (CAN/CSA -Z271-98). The use of the PC3 within the United States is governed by OSHA CFR 29. Consult OSHA CFR-1926 for temporary applications and OSHA CFR 29-1910 for permanent applications.

It is the duty of the employer to provide this manual to each operator.

Power Climber® reserves the right to make changes or modifications to its hoist. Users of this equipment must request current operating information prior to using this equipment. Call your local Power Climber® dealer.

This manual is included with each PC3. Additional copies are available from your Power Climber® dealer. Keep a current copy of this manual with the hoist at all times.

Features of the PC3 Hoist		
Feature	Function	Benefit
Broad Operating Range: 208V, +10%/-15% (\$)	<ul style="list-style-type: none"> ● Significantly improved performance at low voltage ● Proven reliable performance from 170 to 229 run volts ● Tested in 30 min. continuous run tests 	<ul style="list-style-type: none"> ● Reduces service calls ● Extends electric component life ● Eliminates power-induced down time ● Allows longer drops with yoked hoists ● Saves time and money (\$)
Load Sensitive Traction (\$)	<ul style="list-style-type: none"> ● Applies only the traction needed to lift load, not full 1,000 lbs. to 1,500 lbs. lifting force on rope ● Virtually eliminates the risk of wire rope jam 	<ul style="list-style-type: none"> ● Greater tolerance of wire rope condition ● Saves wear and tear on rope, extends wire rope life ● Saves costly wire rope jam in field ● Minimizes the need for rescue ● Minimizes wire rope destruction and lengthy service

Features of the PC3 Hoist (continued)

Feature	Function	Benefit
Voltage Indicator (\$)	<ul style="list-style-type: none"> Indicates proper voltage to unit 	<ul style="list-style-type: none"> Easy visual inspection can eliminate a service call Technician can diagnose voltage problem by phone
Remote Ready	<ul style="list-style-type: none"> Built-in pendant port accepts plug-in remote control Compatible with 8-0281 series remotes 	<ul style="list-style-type: none"> No need to drill and wire remote into hoist Leaves hoist mounted controls operable
Built-in Overspeed Brake	<ul style="list-style-type: none"> Stops hoist in overspeed condition Can't be left behind in shop, bypassed or dismantled 	<ul style="list-style-type: none"> Ensures greater operator safety Improved reliability
Controlled Descent	<ul style="list-style-type: none"> Allows downward travel at a controlled rate of speed in the event of power loss 	<ul style="list-style-type: none"> Eliminates need for rescue Allows self-rescue





OPTIONAL Features of the PC3 Hoist

OPTIONAL Features	Function	Benefit
(Optional) Built-in Secondary Wire Rope (\$)	<ul style="list-style-type: none"> Allows use of secondary suspension wire rope for required applications (double deck, overhead protection, some industrial applications) or to eliminate independent safety lines at very minor additional cost Designed to mount into hoist for maximum durability and security 	<ul style="list-style-type: none"> More versatile hoist ready for any application Eliminates possible loss/damage because it is built-in, rather than an added on Saves money because it is less expensive than other manufacturer's.
(Optional) Overload Kit *standard feature in Canadian hoists	<ul style="list-style-type: none"> Allows to be shop-set to 750 lbs. or to 1250 lbs. on 1500 lbs. models 	<ul style="list-style-type: none"> Reduces rigging material and labor
(Optional) Top Limit Switch (\$)	<ul style="list-style-type: none"> Stops upward travel on contact with an overhead obstruction for special applications 	<ul style="list-style-type: none"> Easy installation



GENERAL SPECIFICATIONS

	Single Phase		Three Phase
Working Load Limit (W.L.L.)	1000 lbs. / 1500 lbs.		1500 lbs.
Power Supply	208 VAC, 60 Hz, Single phase (1000/1500 lbs.)	(*additional model 110VAC, 60 Hz, single phase, 1000 lbs.)	208 VAC, 60Hz, 3 phase
Amperage at W.L.L.	7 amps at 208V 1000# 9.9 amps at 208V 1500#	14 amps at 110V	7 amps at 208V
Wire Rope Diameter	5/16", 8 or 8.4 mm		
Wire Rope Specification	5x26, 6x19 or 6x31, IWRC (Independent Wire Rope Core) or FC (Fiber Core), Right Regular Lay, IPS (Improved Plow Steel) or EIPS (Extra Improved Plow Steel), Preformed, Galvanized or Bright User must verify that the wire rope meets or exceeds applicable codes for breaking strength safety factor. US temporary applications require 6:1 and permanent applications require 10:1.		

HAZARD SYMBOLS SUMMARY

Symbol	Term	Meaning
	STOP	Stop action and follow instructions before continuing
	WARNING	Warns against possible immediate serious injury or death
	CAUTION	Warns against possible injury
	ELECTRICAL HAZARD	Warns against possible electrical shock or hazard

HAZARD SYMBOLS SUMMARY (continued)

Symbol	Term	Meaning
	READ	Must read this before performing any action that follows
	NOTE	Remember and take this into account
	SAFETY GEAR	Mandatory use of safety gear



SAFETY SUMMARY

Every year, workers on swing stages are injured, become disabled, or are killed because of carelessness or because they did not understand how to correctly operate the equipment. Do not become one of them. Know how to use this equipment and prevent accidents.

NEVER operate equipment that you DO NOT understand. You may cause accidents, resulting in injury or death to you or people around you.

This instruction manual is not all inclusive. It is impossible to anticipate every possible way this equipment may be used, and all possible hazardous situations. It is very important that you determine for yourself whether the equipment is safe. You must understand the operating characteristics of this hoist. You must understand how the hoist will operate in your application. You must be certain not to put yourself or others in danger, or cause damage to property or other persons. Call your Power Climber® dealer if you have any questions concerning this equipment.

1. Read and understand this manual **BEFORE** using this equipment.

2. Use the Troubleshooting Guide in this manual to solve problems that may develop with the hoist. Repairs must only be made by people trained and authorized to do so. **NEVER** maintain or repair the equipment while the unit is suspended (above ground level).
3. Be careful when operating the hoist in freezing temperatures. Water or moisture may enter the hoist's overspeed brake or traction assembly. See Cold Weather Operating instructions in this manual.
4. Do not remove any parts from the hoist without replacing them. Do not change or substitute any approved hoist parts for parts that do not meet manufacturer's specifications. Do not modify this hoist without prior approval from Power Climber®. Modifications can put you in danger if not done correctly. Making modifications can also void any manufacturer's warranty and make you liable for any modifications.
5. **WARNING!** Do not use suspended scaffolds unless:
 - a. You are wearing a personal fall arrest system that meets or exceeds your application requirements.
 - b. You have personally made sure that
 - a. the roof support system is complete, properly assembled, counterweighted (or otherwise anchored), tied off, and not overloaded; and
 - b. hoists and platforms are not overloaded.
 - c. The wire rope is free of defects and is the size and type specified for the hoist.
 - d. Guardrails and toe boards are properly installed.
 - e. The main suspension wire rope is vertical.

Setup and use must comply with Power Climber® instructions, OSHA, and other applicable codes. Copies are available from your local Power Climber® dealer.

6. Do not reset the overspeed brake until you have first read and completely understand the Troubleshooting Guidelines in this manual.
7. Do not use visibly worn, kinked, bird-caged, undersized, or damaged wire rope. Protect wire rope from sharp or abrasive edges of building. Do not use wire rope that has been exposed to fire, excessive wear, corrosive atmosphere, chemicals, passage of electric current, or temperatures above 200 ° F.
8. Inspect the wire rope before rigging. Handle, inspect, and maintain wire rope carefully during and after each job. Lubricate the wire rope according to the manufacturer's recommendations.
9. When welding from a suspended scaffold, provide proper electrical grounding for this hoist.

- a. When welding from a suspended scaffold: (Within the US reference OSHA CFR 29-1926.451(f)(17)
 - b. Assure platform is grounded to the structure.
 - c. Insulate wire rope 4 feet above and below the platform.
 - d. Insulate wire rope at suspension point and assure that the wire rope cannot contact the structure along its entire length, including the tail line.
 - e. Cover the hoist with an insulating material.
11. Never operate an electric hoist in an explosive atmosphere such as a refinery, chemical plant, grain elevator, distilleries, ship or silo interiors, mines, around coal handling equipment, or around explosive organic vapors or dust.
 12. Never use hoists and aluminum platforms around caustic materials, acids, or acid fumes. Use hoist covers when corrosive materials are present.
 13. Maintain clearances and make sure no obstructions interfere with vertical travel.
 14. Avoid power lines. Make sure the platform or hand tools cannot swing or be blown within 10 feet of a power line. Never, under any circumstances, rig a platform above electrical power lines.
 15. Push the operating switch by hand only. Do not use foreign objects to operate the hoist.
 16. When not in use, store hoist and stage to protect from unauthorized use. Cover the hoist if possible. Always unplug power cord when not in use and equipment is not attended.
 17. Do not allow anyone under suspended equipment. If necessary, provide protection below the suspended equipment to prevent injury to people from falling objects. Use lanyards to secure tools and materials from falling on personnel below.
 18. Use approved personnel harnesses, lanyards, rope grabs, and independent lifelines at all times. Attach the lifelines to a structural member of the building, never to part of the rigging unless specifically designed for this purpose.
 19. Comply with all local, state and federal safety codes and equipment instructions.
 20. Only authorized and properly trained personnel shall operate this hoist. Each operator must determine his own fitness to operate this hoist. Consult your doctor if you are in doubt. Each operator must not be under the influence of alcohol or drugs.
 21. If you hear any strange noises or if the hoist does not appear to work normally, stop using it immediately. Do not continue to use the equipment until it is repaired.

HAZARD SUMMARY



WARNING

If the hoist is suspended in the air and the motor runs but the wire rope does not move through the hoist, **STOP** the hoist immediately! Damaged wire rope may be jammed inside the hoist. Any attempt to move the hoist up or down could damage the equipment or cause injury or death.

There are many hazards when working on a suspended scaffold. The following are common hazards. The list is not complete. It is provided to increase safety awareness on the job site.

MECHANICAL HAZARDS

- **Crushing** between the platform and the building.
- **Cutting or severing** between moving machine parts.
- **Loss of rigging stability** because of one or more of the following:
 - Insufficient counterweight or counterweights not properly fixed
 - Inadequate mechanical strength
 - Increase in vertical load on suspension wire because the platform encounters an obstacle, the platform overloads, or the suspension wire rope breaks
 - Platform catches on overhang when going up
- **Falling**
 - from the platform when working
 - by using a wire rope that is too short
 - if the platform is not strong enough for the weight and breaks
 - if wire rope or platform interconnections fail
 - rigging failure can cause falling
- **Idling** due to loss of traction.
- **Jamming** due to damaged wire rope



ELECTRICAL HAZARDS

- Failure of the electrical supply may delay travel of the platform
- Control system failure can cause unwanted movement of the platform
- Improper power supply (voltage or frequency) may damage the hoist

ENVIRONMENTAL HAZARDS

- Consider and prepare for the effects of climate. (Heat/Cold/Ice/Wind)
- Sandblasting and acid wash procedures may introduce special concerns. They may affect the immediate health of an operator and may pose serious risks to the hoist and other equipment being used.



HAZARD PREVENTION

- All electrical connections must be locked and supported by strain relief devices.
- Make sure the electrical cord and wire rope are long enough to allow full travel of the suspended equipment.



WIRE ROPE

<u>GENERAL SPECIFICATIONS</u>	
Wire Rope Diameter	5/16", 8 or 8.4 mm
Wire Rope Specification	5x26, 6x19 or 6x31, IWRC (Independent Wire Rope Core) or FC (Fiber Core), Right Regular Lay, IPS (Improved Plow Steel) or EIPS (Extra Improved Plow Steel), Preformed, Galvanized or Bright. User must verify that the wire rope meets or exceeds applicable codes for breaking strength safety factor. US temporary applications require 6:1 and permanent applications require 10:1.

1. Wire rope requires lubrication under normal conditions. Lightly lubricate it with a wire rope lubricant specified by the wire rope manufacturer monthly or more often if necessary.
2. To prepare the end of IWRC wire rope for insertion, cut back the steel center at least 2 inches to allow for independent movement of the core. Braze and rough shape the end of the wire rope to form a smooth, tapered, bullet shape no more than 1/4-in. long. **DO NOT** cool the end of the hot wire rope in water or oil. This makes the end brittle and may cause it to break off. Oil the bullet after it cools to prevent rusting. (FC wire rope only needs to have the bullet prepared, there is no reason to cut back the center of this rope.)
3. Always uncoil and carefully examine the wire rope before use. Worn, kinked, bird-caged, or damaged wire rope cannot be repaired. It must be replaced.

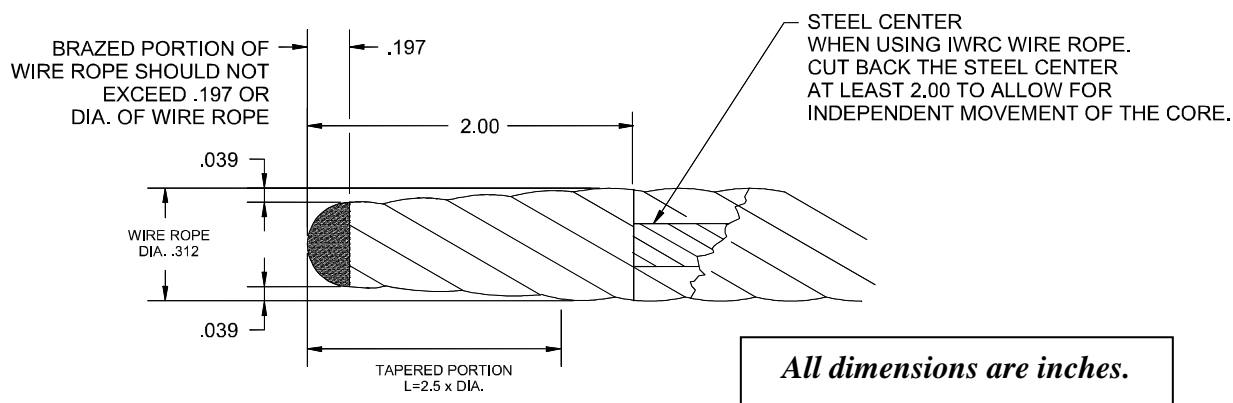

4. Use a heavy-duty thimble for the main suspension wire rope and follow the manufacturer's requirements for termination of the wire rope hardware that you are using.

WARNING

Wire rope stretches when loaded. The diameter is reduced. Always inspect the wire rope termination and refer to the manufacturer's inspection procedures.

5. Be sure there is enough wire rope to reach the lowest possible point of travel.
6. Wire rope begins to wear the moment it is used. It must be regularly inspected to be sure it is in good condition. Wire rope must be removed from service when diameter loss or wire breakage occurs as listed within ANSI A10.4

If it is not possible to lower the platform to the ground, secure the tail line* to prevent the platform from running off the suspension ropes. Before rigging in such an area, consult a safety professional.



***Tail line with loop termination**



NOTE: Do not expose the wire rope to fire, temperatures above 200 ° F., passage of electrical current, or corrosive atmospheres and chemicals. This exposure will make the rope unsafe.

Acids will corrode and reduce the strength of both the inner and outer strands. When using corrosive chemicals discard the wire rope after completing the project, or sooner if any damage is evident. Do not save wire rope that has been in contact with corrosives. When in doubt, replace the wire rope.



FRONT AND BACK VIEWS OF HOIST

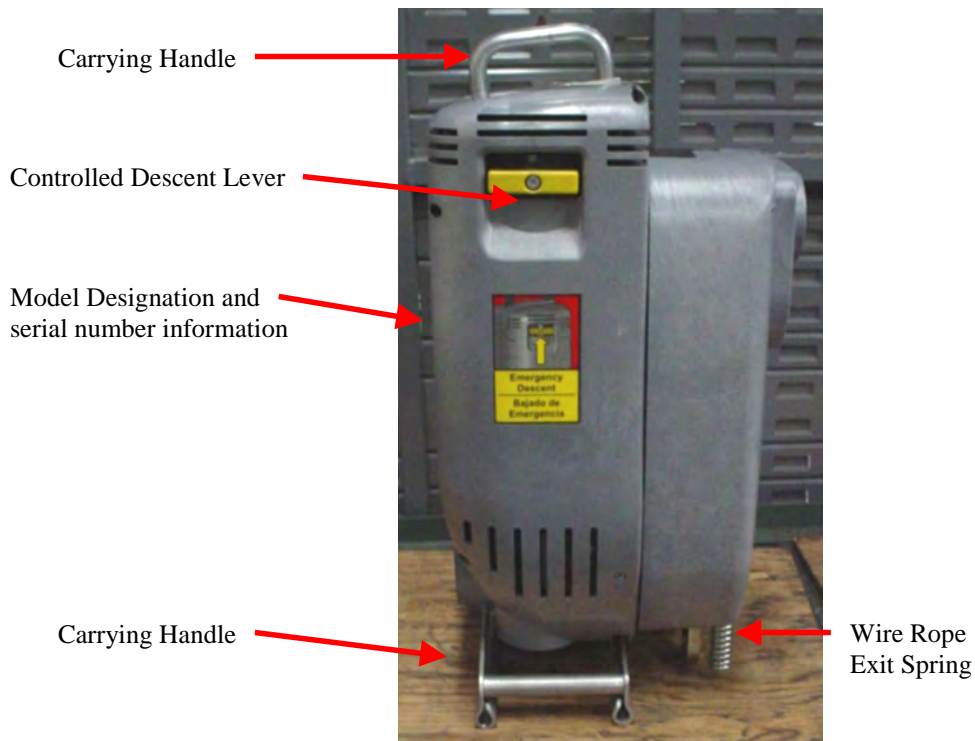
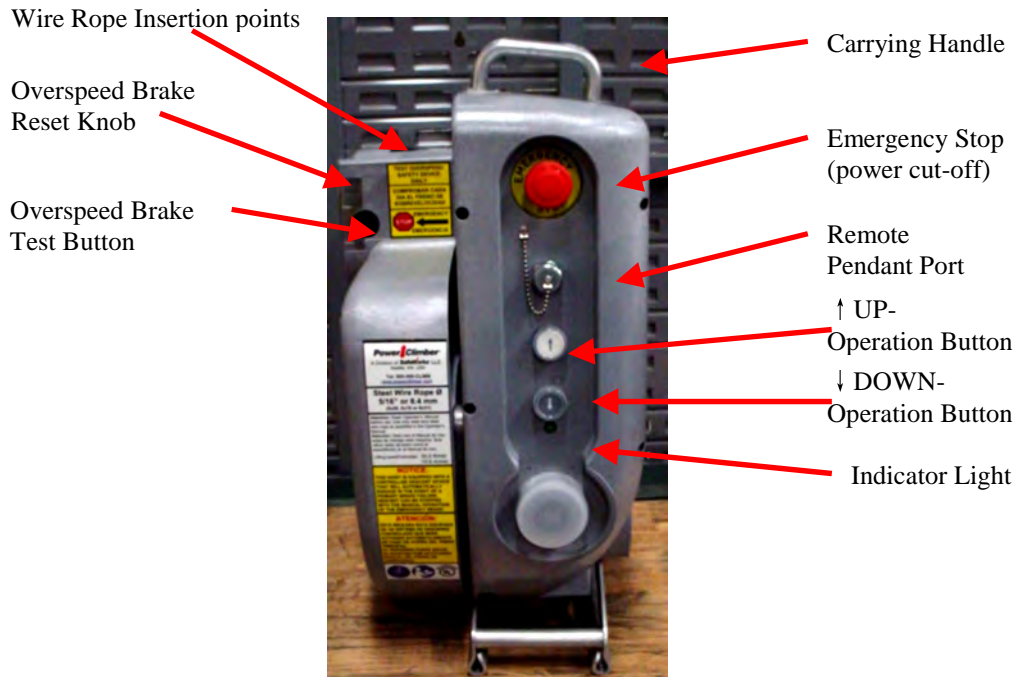

INSTALLING HOIST TO PLATFORM

- □ Follow the manufacturer's instructions for platform assembly.
- Attach the hoist stirrup bar to the platform stirrup. (A & B)
- The hoist can be lifted into position by hand or under power.
- Connect the hoist to the power supply.
- All electric hoists have a twist lock plug. (C) The power indicator light will light up when the hoist receives power.



A



B



C

CAUTION

- ▲ ● The electric supply must have sufficient capacity, and the circuit breakers must be properly rated.



NOTE

- The voltage loss for 100' of 10/3 electrical cable is 2 volts for each hoist used
- If startup is sluggish, determine the voltage at the motors when running ↑ UP is between 170-220 VAC

If the voltage is lower than 170 VAC when running:

- Increase voltage with at transformer at power source when voltage is low **OR**,
- Use larger gauge or separate electrical cables to each hoist to improve voltage supply
- Do not start both hoists at the same time to insure better hoist performance. Always maintain a level platform.

- ▲ = Inspect
- = Verify
- = Perform Process





REEVING MAIN SUSPENSION WIRE ROPE

- Push the main suspension wire rope bullet through the “Wire Rope Insertion Point” approximately 15 inches
- Operate the hoist in the ↑ UP direction while pushing the rope into the hoist.
- Make sure the wire rope runs freely through the “Wire Rope Exit Spring”



REEVING SECONDARY WIRE ROPE (OPTIONAL)

- Push the secondary wire rope bullet through the “Wire Rope Insertion Point” for the secondary until it exits the hoist
- Attach a 25 lb. weight to the end of the secondary wire rope to assist secondary rope travel

- ▲ = Inspect
- = Verify
- = Perform Process



DAILY TEST REQUIREMENT

WARNING

Perform all daily tests to ensure correct operation! Do not use the hoist for lifting until you have successfully completed the daily tests.

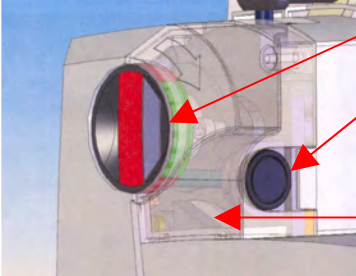
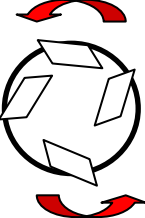
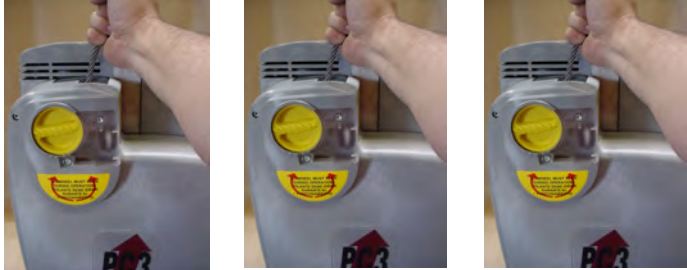

The following tests must be performed at the start of each work shift. If the hoist fails any test, DO NOT use it until it is repaired. Refer to the pictures on page 12 to identify components. All tests are performed at or near ground level.

<p>PowerClimber®</p>	<p>TESTING OVERSPEED BRAKE</p>	
<p>●■ While powering the hoist ↑ UP and ↓ DOWN approximately 3 feet, look through the window near the Overspeed Brake Test Button to view that the flywheel is turning.</p>	 <p>Ready to receive wire rope</p> 	<p><u>Overspeed Brake Reset Knob</u></p> <p><u>Overspeed Brake Test Button</u> (can be used for testing the Overspeed Brake, and for stopping descent)</p> <p><u>Flywheel</u> is observed through this area of the clear cover</p> <p>Flywheel must turn while hoist is operating.</p>
<p>■ Dereeve the wire rope</p> <ol style="list-style-type: none"> 1. Re-insert the wire rope about 12 in. into the hoist. 2. Holding the wire rope firmly, pull it out quickly. If the brake is working correctly it will grab and hold the wire rope in less than 4 in. 3. Repeat this test at least 3 times. If the brake does not work correctly every time, return the hoist to your Power Climber® dealer. DO NOT USE THIS HOIST. 	 <p>▲ = Inspect ● = Verify ■ = Perform Process</p>	

4. Reset the overspeed brake.
(Turn knob clockwise)

Overspeed Brake has tripped

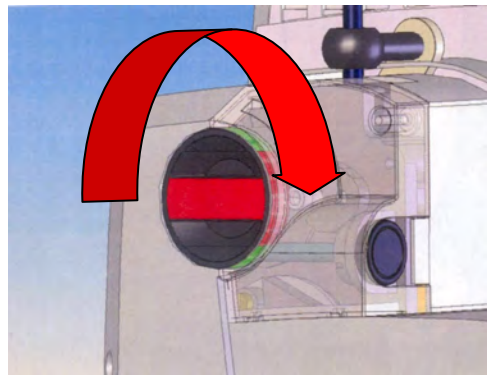

TESTING OVERSPEED BRAKE TEST BUTTON

- Push the ↑ UP control button and raise the platform approximately 3 feet
- While pushing the ↓ DOWN control button, push the Overspeed Brake Test Button
- The hoist should stop quickly



↑ UP-
Operation Button

↓ DOWN-
Operation Button

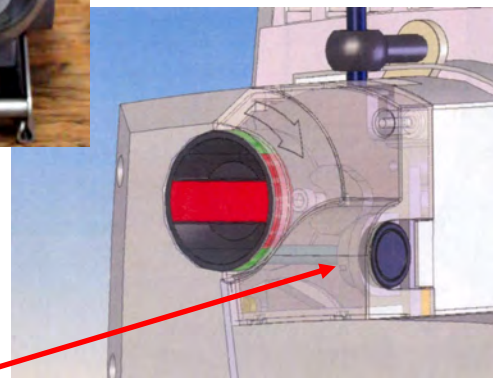

Overspeed Brake Test Button

- ▲ = Inspect
- = Verify
- = Perform Process

RESETTING THE OVERSPEED BRAKE

■ Power the hoist ↑ UP a few inches, at the same time turning the reset knob clockwise until the reset knob engages.

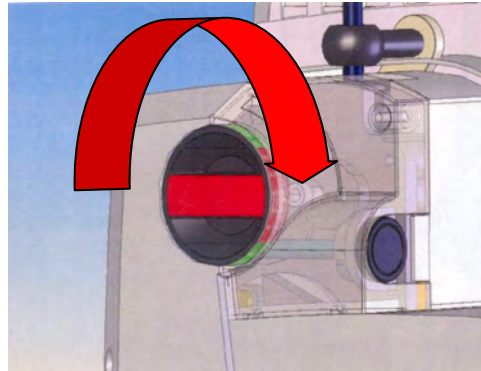

TESTING THE EMERGENCY STOP BUTTON

■ While running the hoist in either direction, press the red Emergency Stop Button

● The hoist should not run in either direction.

● ■ To reset, turn button clockwise



Emergency Stop Button

▲ = Inspect

● = Verify

■ = Perform Process

TESTING THE CONTROLLED DESCENT FEATURE

- Raise the hoist approximately 3 ft.
- Disconnect the power supply. During this test, or when you are actually using the controlled descent feature, **CAREFULLY** pull the Controlled Descent Lever, making sure that the hoist does not overspeed. The hoist should descend at a slow, controlled speed.

- ▲ = Inspect
- = Verify
- = Perform Process

Controlled Descent Lever
Allows downward travel at a controlled speed without power.



CAUTION

If the overspeed brake trips while doing this test, the controlled descent system is not working properly and the hoist should not be used.



DAILY INSPECTION

	<h2 style="margin: 0;">DAILY INSPECTIONS</h2>
<p>▲ Inspect</p> <ul style="list-style-type: none"> ● Wire rope ● Power supply ● Rigging ● Platform ● Hoist <p>● Verify all parts are present, in proper working order and are not damaged.</p> <p>▲ = Inspect ● = Verify ■ = Perform Process</p>	<p>▲● Bolts, nuts and clamps must be well secured.</p> <p>▲● Make sure hoist is secured to the stirrup with SAE Grade 5 fasteners and lock nuts are properly installed.</p>
<h2 style="margin: 0;">NOTE</h2>	<p>▲ When using the hoist in a dirty environment that contains epoxy, paint, cement, sand blast residue, or corrosive material, inspect the operation of the secondary overspeed brake several times a day. Protective hoist covers are recommended in these environments. Contact your Power Climber® dealer.</p>



OPERATING THE HOIST

WARNING

BEFORE operating this hoist you must understand and follow the instructions in this manual. You must be properly trained, physically fit, and authorized to operate the hoist. Failure to comply with these instructions could result in serious injury or death.





SAFETY NOTES

- **DO NOT** operate the hoist if you hear unusual noises.
- **DO NOT** operate the hoist if adjustments or repairs seem necessary.
- **DO NOT** operate the hoist if any warning, operating, or capacity instructions are unclear, missing, illegible or damaged.

Report any problems to your supervisor and also notify the next operator when changing shifts. Tag the hoist “DO NOT USE UNTIL REPAIRED.”

- **NEVER** operate an electric hoist or any electrical equipment in an explosive atmosphere. Explosive atmospheres exist around refineries, chemical plants, grain elevators, distilleries, inside of silos, mines or around coal handling equipment. This is not a complete list. Consult an expert if you are in doubt about the safety of your immediate surroundings.



PowerClimber®

NORMAL OPERATION

- For routine ↑ UP travel or ↓ DOWN travel of the hoist, push the ↑ UP or ↓ DOWN control button. The buttons are spring loaded and return to the off position and apply the brake when released. If the hoist does not stop right away press the Emergency Stop and the Overspeed Brake Test Button
- Unplug the electric supply plug from the power source.



Overspeed Brake Test Button

Emergency Stop Button

↑ UP- Operation Button

↓ DOWN- Operation Button

- ▲ = Inspect
- = Verify
- = Perform Process

COLD WEATHER OPERATION

■ When operating the hoist in cold weather, test the secondary overspeed brake frequently.

●▲ Make sure it is not frozen. If the brake does not stop the hoist, **DO NOT USE** the hoist until the brake has been thawed, dried, and is in proper working condition.

■ Thaw out the brake by blowing ducted dry heat (150° F max.) on the brake area. This can be done with an ordinary hair dryer.

▲ = Inspect
 ● = Verify
 ■ = Perform Process

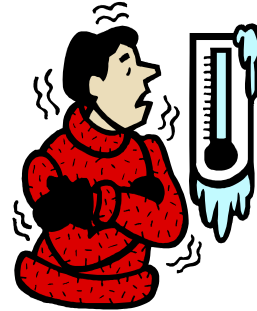

■ **DO NOT USE** open flame on the unit.

● **If the unit will not operate properly after thawing, DO NOT USE. If the hoist will not climb or descend during these tests, do not use the hoist unless this is corrected during the thaw out process.**

■ Return the hoist to your Power Climber® dealer.

WARNING

Be extremely careful when using the hoist in freezing temperatures. Frequently check for normal hoist operation. All tests must be done within 3 feet of ground level.



DEREEVING

REMOVING THE MAIN SUSPENSION WIRE ROPE

● Make sure that the platform is properly supported on a stable surface before putting slack on the main suspension wire rope to prevent hoists and platform from tipping and causing injury.

■ While on the ground, the main suspension line will wind out of the hoist when the ↓ DOWN control button is pushed.

■ You may have to help remove the last 15 inches of wire rope.
 ■ Grab the wire rope above the rope insertion point, hold the Overspeed Brake Reset Knob in the “reset” position, and slowly pull the main suspension wire rope out of the hoist.

▲ = Inspect
 ● = Verify
 ■ = Perform Process

REMOVING THE SECONDARY WIRE ROPE (OPTIONAL)

● Make sure that the platform is properly supported on a stable surface before putting slack on the main suspension wire rope to prevent hoists and platform from tipping and causing injury.

1. ▲● There should be no slack on the main suspension wire rope.
2. ■ Before the main suspension line has been removed from the hoist, remove the counterweight from the end of the secondary wire rope.
3. ■ Pull the secondary wire rope out of the hoist by hand.

If you are removing both wire ropes from the hoist on a stable surface, you must remove the secondary wire rope before removing the main suspension wire rope.

▲ = Inspect
● = Verify
■ = Perform Process



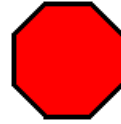

	<h2 style="margin: 0;">MAINTENANCE</h2>
<p>▲ = Inspect ● = Verify ■ = Perform Process</p>	<p>● The hoist should be returned to a Power Climber® dealer for periodic maintenance at least once a year from date of being placed into use.</p> <p>●▲ More frequent service may be required if the hoist is subjected to dirty environments.</p> <p>▲●■ If the hoist fails any inspection or operation, it should be returned for service.</p>

TROUBLESHOOTING GUIDELINES

	<p style="text-align: center;">STOP! Read all Troubleshooting Guidelines before attempting any solution.</p>
<h2 style="margin: 0;">TROUBLESHOOTING GUIDELINES</h2>	
Problem	Possible Cause and Solution
<p>1. No Power to the platform</p> <p>(● Low voltage indicator light is off)</p> <p>■ Consult your supervisor to correct problems</p> <p>▲ = Inspect ● = Verify ■ = Perform Process</p>	<p>a. ● Power at the junction box is off</p> <p>b. ● Circuit breaker is tripped</p> <p>c. ● ■ Plugs are not connected (check hoist, yoke, power cord and power source)</p> <p>d. ● Damaged electrical cord</p> <p>e. ●▲ Power indicator light is burned out</p> <p>f. ● Not enough power is being supplied to hoist.</p> <p>g. ● ■ If the indicator light comes back on after about 30 seconds, thermal (TH2) has tripped due to excessive amperage. Consult with your supervisor and check for low voltage.</p>



TROUBLESHOOTING GUIDELINES (continued)

<p>2. Hoist does not run</p> <p>(● Low voltage indicator light is on)</p>	<p>a. ●■ If the motor is hot, motor thermal may have tripped. Allow motor to cool and see if it resets. This may take 30 minutes or more.</p> <p>b. ● Frequent stops and starts, high outside temperature, a dragging brake, or overloading can cause the motor to heat up.</p>
<p>3. Wire rope will not reeve</p>	<p>a. ■ Increase hand pressure on the wire rope while pushing the ↑ UP button.</p> <p>b. ■ Take the wire rope out, turn it 180° and put it back into hoist while pushing the ↑ UP button.</p> <p>c. ●■ Poor bullet, prepare a new end.</p> <p>d. ●■ End of wire rope is bent or kinked, prepare a new end.</p> <p>e. ●■ Dirt or other material is obstructing inside the hoist, clean out with air or flush with water.</p>
<p>4. Motor runs normally but hoist will not lift</p>	<p>a. ● Make sure that the bullet end of the wire rope has come out of the wire rope exit spring</p> <p>b. ▲ ■ Inspect the wire rope for damage or wear, replace as necessary</p> <p>c. ▲ WIRE ROPE MAY BE JAMMED, DO NOT CONTINUE TO OPERATE, CALL YOUR SUPERVISOR.</p>
<p>5. Hoist hums, starts slowly, is sluggish</p>	<p>a. ● Check for correct run voltage, correct as necessary</p> <ul style="list-style-type: none"> ● ■ Run separate cords for each hoist ● ■ Use shorter cords ● ■ Use cord with larger wires ● ■ Add a booster transformer at the power source
<p>6. Overspeed flywheel does not turn while hoist moves ↑ UP or ↓ DOWN</p> <p>▲ = Inspect ● = Verify ■ = Perform Process</p>	<p>a. ● If you are in the air, push the Overspeed Brake Test Button and wait to be rescued. DO NOT USE UNTIL THIS HAS BEEN REPAIRED.</p> <p>b. ● If you are on the ground, check and correct the following as needed</p> <ul style="list-style-type: none"> ● ▲ ■ Obstructions such as dirt or other materials ● ▲ Wire rope may be worn out, call your supervisor ● ▲ Hoist parts may be worn out, call your supervisor.

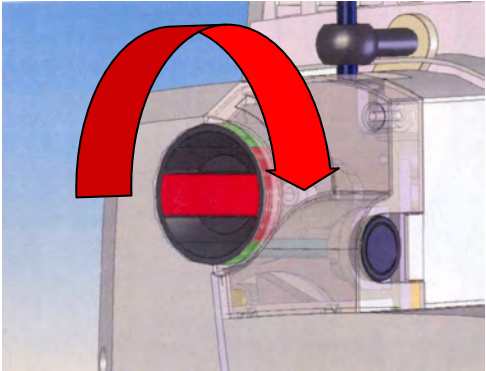

TROUBLESHOOTING GUIDELINES (continued)

<p>7. Cannot reset the Overspeed Brake Reset Knob</p> <p align="center">WARNING</p>	<p>▲ ● DO NOT RESET THE OVERSPEED UNTIL</p> <ul style="list-style-type: none"> You have determined that there is enough wire rope to reach a safe landing surface You know that the wire rope is not jammed in the hoist You know the reason that the overspeed has been tripped and there is no danger when it is reset.
<p>Cannot reset the Overspeed Brake Reset Knob</p> <p align="center"><i><u>(SEE Previous Step)</u></i></p>	<p><input type="checkbox"/> Power the hoist ↑ UP a few inches, at the same time turning the reset knob clockwise until the reset knob engages.</p> 
<p>9. Hoist does not stop immediately when the ↓ DOWN button is released</p>	<ul style="list-style-type: none"> <input type="checkbox"/> Push in the Overspeed Brake Test Button and wait to be rescued <input type="checkbox"/> Call your supervisor <input type="checkbox"/> Return the hoist to be serviced by a Power Climber® dealer
<p>10. You hear unusual noises coming from the hoist</p> <p>▲ = Inspect ● = Verify ■ = Perform Process</p>	<p>If you are in the air:</p> <ul style="list-style-type: none"> <input type="checkbox"/> Push in the Emergency Stop button <input type="checkbox"/> Push in the Overspeed Brake Test Button and wait to be rescued <input type="checkbox"/> Unplug the hoist from the power cord <input type="checkbox"/> Call your supervisor <input type="checkbox"/> Return the hoist to be serviced by a Power Climber® dealer



TROUBLESHOOTING GUIDELINES (continued)



<h1 style="color: red; margin: 0;">WARNING</h1>	<b style="color: red;">WARNING: You may have a rope jam. Any attempt to operate the hoist could cause serious injury or death.
<p>▲ = Inspect ● = Verify ■ = Perform Process</p>	<p>If you are on the ground:</p> <ul style="list-style-type: none"> ●■ Check for damaged wire rope and replace as needed ●■ Check for dirt on the wire rope and clean/lubricate as needed ●■ Check the hoist for visible signs of damage, call supervisor and return hoist for service

		HOIST LABELS
<h3 style="margin: 0;">FRONT</h3> <div style="text-align: center;"> </div> <div style="text-align: center; margin-top: 10px;"> </div>	<h3 style="margin: 0;">BACK</h3> <div style="text-align: center;"> </div>	<h3 style="margin: 0;">SIDE</h3> <div style="text-align: center;"> </div> <div style="text-align: center; margin-top: 10px;"> </div>

**CODE OF SAFE PRACTICES
FOR
SUSPENDED SCAFFOLDS
DEVELOPED FOR INDUSTRY BY SCAFFOLDING, SHORING & FORMING
INSTITUTE (SSFI)
and SCAFFOLD INDUSTRY ASSOCIATION, INC. (SIA)**

It shall be the responsibility of all users to read and comply with the following common sense guidelines which are designed to promote safety in the erecting, dismantling and use of suspended scaffolds. These guidelines do not purport to be all-inclusive nor to supplant or replace other additional safety and precautionary measures to cover usual or unusual conditions. If these guidelines in any way conflict with any state, local, provincial, federal or other government statute or regulation, said statute or regulation shall supersede these guidelines and it shall be the responsibility of each user to comply therewith.

I. GENERAL GUIDELINES

- A. POST THESE SAFETY GUIDELINES** in a conspicuous place and be sure that all persons who erect, use, locate, or dismantle suspended scaffold systems are fully aware of them and also use them in tool box safety meetings.
- B. FOLLOW ALL EQUIPMENT MANUFACTURERS' RECOMMENDATIONS** as well as all state, local and federal codes, ordinances and regulations relating to suspended scaffolding.
- C. SURVEY THE JOB SITE.** A survey shall be made of the job site by a competent person for hazards such as exposed electrical wires, obstructions that could overload or tip the suspended scaffold when it is raised or lowered, unguarded roof edges or openings, inadequate or missing tiebacks. Those conditions should be corrected before installing or using suspended scaffold systems.
- D. INSPECT ALL EQUIPMENT BEFORE EACH USE.** Never use any equipment that is damaged or defective in any way. Mark it or tag it as damaged or defective equipment and remove it from the jobsite.
- E. ERECT AND DISMANTLE SUSPENDED SCAFFOLD EQUIPMENT** in accordance with design and / or manufacturer's recommendations.
- F. DO NOT ERECT, DISMANTLE, OR ALTER SUSPENDED SCAFFOLD SYSTEMS** unless under the supervision of a competent person.
- G. DO NOT ABUSE OR MISUSE SUSPENDED SCAFFOLD EQUIPMENT.** Never overload platforms or hoists.
- H. ERECTED SUSPENDED SCAFFOLDS SHOULD BE CONTINUOUSLY INSPECTED** by the user to be sure that they are maintained in a safe condition. Report any unsafe condition to your supervisor.
- I. NEVER TAKE CHANCES! IF IN DOUBT REGARDING THE SAFETY OR USE OF SUSPENDED SCAFFOLDS, CONSULT YOUR SCAFFOLD SUPPLIER.**
- J. NEVER USE SUSPENDED SCAFFOLD EQUIPMENT FOR PURPOSES OR IN OTHER WAYS FOR WHICH IT WAS NOT INTENDED.**
- K. CARE SHOULD BE TAKEN WHEN OPERATING AND STORING EQUIPMENT DURING WINDY CONDITIONS.**
- L. SUSPENDED SCAFFOLD SYSTEMS** should be installed and used in accordance with the manufacturer's recommended procedures. Do not alter components in the field.
- M. SUSPENDED PLATFORMS MUST NEVER BE OPERATED NEAR LIVE POWER LINES** unless proper precautions are taken. Consult the power service company for advice.
- N. ALWAYS ATTACH FALL ARREST EQUIPMENT** when working on suspended scaffolds.

- O. DO NOT WORK ON OR INSTALL SUSPENDED SCAFFOLDS** if your physical condition is such that you feel dizzy or unsteady in any way.
- P. DO NOT WORK ON SUSPENDED SCAFFOLDS** when under the influence of alcohol or illegal drugs.

II. GUIDELINES FOR ERECTION AND USE OF SUSPENDED SCAFFOLD SYSTEMS

A. RIGGING:

- 1. WEAR FALL PREVENTION EQUIPMENT** when rigging on exposed roofs or floors.
- 2. ROOF HOOKS, PARAPET CLAMPS, OUTRIGGER BEAMS, OR OTHER SUPPORTING DEVICES** must be capable of supporting the hoist machine rated load with a factor of safety of 4.
- 3. VERIFY THAT THE BUILDING OR STRUCTURE WILL SUPPORT** the suspended loads with a factor of safety of 4.
- 4. ALL OVERHEAD RIGGING** must be secured from movement in any direction.
- 5. COUNTERWEIGHTS USED WITH OUTRIGGER BEAMS** must be of a non-flowable material and must be secured to the beam to prevent accidental displacement.
- 6. OUTRIGGER BEAMS THAT DO NOT USE COUNTERWEIGHTS** must be installed and secured on the roof structure with devices specifically designed for that purpose. Direct connections shall be evaluated by a competent person.
- 7. TIE BACK ALL TRANSPORTABLE RIGGING DEVICES.** Tiebacks shall be equivalent in strength to suspension ropes.
- 8. INSTALL TIEBACKS AT RIGHT ANGLES TO THE FACE OF THE BUILDING** and secure, without slack, to a structurally sound portion of the structure, capable of supporting the hoisting machine rated load with a safety factor of 4. **IN THE EVENT THAT TIEBACKS CANNOT BE INSTALLED AT RIGHT ANGLES,** two tiebacks at opposing angles must be used to prevent movement.
- 9. RIG AND USE HOISTING MACHINES DIRECTLY UNDER THEIR SUSPENSION POINTS.**

B. WIRE ROPE AND HARDWARE:

- 1. USE ONLY WIRE ROPE AND ATTACHMENTS** as specified by the hoisting machine manufacturer.
- 2. ASSURE THAT WIRE ROPE IS LONG ENOUGH** to reach to the lowest possible landing.
- 3. CLEAN AND LUBRICATE WIRE ROPE** in accordance with the wire rope manufacturer's instructions.
- 4. HANDLE WIRE ROPE WITH CARE.**
- 5. COIL AND UNCOIL WIRE ROPE** in accordance with manufacturer's instructions in order to avoid kinks or damage.
- 6. TIGHTEN WIRE ROPE CLAMPS** in accordance with the clamp manufacturer's instructions.
- 7. INSPECT WIRE ROPE IN ACCORDANCE WITH MANUFACTURER'S INSTRUCTIONS. DO NOT USE WIRE ROPE THAT IS KINKED, BIRDCAGED, CORRODED, UNDERSIZED, OR DAMAGED IN ANY WAY.** Do not expose wire rope to fire, undue heat, corrosive atmosphere, electricity, chemicals or damage by tool handling.
- 8. USE THIMBLES AND SHACKLES AT ALL WIRE ROPE SUSPENSION TERMINATIONS.**
- 9. USE J-TYPE CLAMPS OR SWEDGE FITTINGS. Do not use U-bolts. Retighten J Clamps under load and retighten daily.**
- 10. WIRE ROPES USED WITH TRACTION HOISTS MUST HAVE PREPARED ENDS.** Follow manufacturer's recommendations.

C. POWER SUPPLY FOR MOTORIZED EQUIPMENT:

- 1. GROUND ALL ELECTRICAL POWER SOURCES AND POWER CORD CONNECTIONS and protect them with circuit breakers.**
- 2. USE POWER CORDS OR AIR HOSES OF THE PROPER SIZE THAT ARE LONG ENOUGH** for the job.
- 3. POWER CORD OR AIR HOSE CONNECTIONS MUST BE RESTRAINED** to prevent their separation.
- 4. USE STRAIN RELIEF DEVICES TO ATTACH POWER CORDS OR AIR SUPPLY HOSES TO THE SUSPENDED SCAFFOLD** to prevent them from falling.
- 5. PROTECT POWER CORDS OR AIR HOSES AT SHARP EDGES.**
- 6. USE GFI WITH POWER TOOLS.**

D. FALL ARREST EQUIPMENT:

- 1. EACH PERSON ON A SUSPENDED SCAFFOLD must be attached to a separate fall arrest system unless the installation was specifically designed not to require one.**
- 2. EACH LIFELINE MUST BE FASTENED IN ACCORDANCE WITH MANUFACTURER'S INSTRUCTIONS** to a separate anchorage capable of holding a minimum of 5000 pounds.
- 3. DO NOT WRAP LIFELINES AROUND STRUCTURAL MEMBERS** unless lifelines are protected and a suitable anchorage connection is used.
- 4. PROTECT LIFELINES AT SHARP CORNERS** to prevent chafing.
- 5. RIG FALL ARREST SYSTEMS** to prevent free fall in excess of six feet.
- 6. SUSPEND LIFELINES FREELY** without contact with structural members or building façade.
- 7. USE LIFELINES OF SIZE AND CONSTRUCTION that are compatible with the rope grab use.**
- 8. ASSURE A PROPERLY ATTACHED ROPE GRAB IS INSTALLED ON EACH LIFELINE IN THE PROPER DIRECTION.** Install in accordance with the manufacturer's recommendations.
- 9. KEEP ROPE GRAB POSITIONED ABOVE YOUR HEAD LEVEL.**
- 10. USE ONLY FULL BODY HARNESES** of the proper size and that are tightly fastened.
- 11. ASSURE FULL BODY HARNESS HAS LANYARD attachment with D-ring at the center of your back.**
- 12. CONSULT FALL PROTECTION SUPPLIER FOR INSPECTION PROCEDURE. INSPECT FALL PROTECTION ANCHORAGE / EQUIPMENT BEFORE EACH USE.**
- 13. WHEN A SECONDARY WIRE ROPE SYSTEM IS USED,** a horizontal lifeline secured to two or more structural members of the scaffold in lieu of vertical lifelines.

E. DURING USE:

- 1. USE ALL EQUIPMENT AND ALL DEVICES** in accordance with the manufacturer's instructions.
- 2. DO NOT OVERLOAD, MODIFY, OR SUBSTITUTE EQUIPMENT.**
- 3. BEFORE COMMENCING WORK OPERATIONS preload wire rope and equipment with the maximum working load, then retighten wire rope rigging clamps and recheck rigging to manufacturer's recommendations.**
- 4. INSPECT ALL RIGGING EQUIPMENT AND SUSPENDED SCAFFOLD SYSTEMS DAILY.**
- 5. INSPECT WIRE ROPE DURING EACH ASCENT OR DESCENT FOR DAMAGE.**
- 6. USE CARE TO PREVENT DAMAGE TO EQUIPMENT** by corrosive or other damaging substances.
- 7. CLEAN AND SERVICE EQUIPMENT REGULARLY.**

- 8. ALWAYS MAINTAIN AT LEAST (4) FOUR WRAPS OF WIRE ROPE ON DRUM TYPE HOISTS.**
- 9. DO NOT JOIN PLATFORMS** unless the installation was designed for that purpose.
- 10. ONLY MOVE SUSPENDED SCAFFOLDS HORIZONTALLY WHEN NOT OCCUPIED.**
- 11. WHEN RIGGING FOR ANOTHER DROP assure sufficient wire rope is available before moving the suspended scaffold system horizontally.**
- 12. WHEN WELDING FROM SUSPENDED SCAFFOLDS:**
 - a. Assure platform is grounded to structure.
 - b. Insulate wire rope above and below the platform.
 - c. Insulate wire rope at suspension point and assure wire does not contact structure along its entire length.
 - d. Prevent the bitter end from touching the welding ground.

Since field conditions vary and are beyond the control of the SSFI and the SIA, safe and proper use of suspended scaffolding is the sole responsibility of the user.

Reprinting of this publication does not imply approval of product by the Institute or indicate membership in the Institute.

© Permission to reproduce in entirety can be obtained from:
Scaffolding, Shoring & Forming Institute
1300 Sumner Ave., Cleveland, Ohio 44115

Publication SP201

Printed in U.S.A 2/99
(2700)